

1 Unpack

Taking the TV Out of the Box



- **Warning:**
Do not touch the TV's screen when you take it out of the box. Hold it by its edges only. If you touch the screen, you can cause the TV panel to crack.
- **Recommendation 1:**
Two people should remove the TV from the box as shown above. When removing the TV, hold it by its edges only. Do not touch the screen.
- **Recommendation 2:**
If only one person is available to remove the TV from the box, remove it as shown in the illustration above. Hold the TV by its edges. Do not touch the screen.

Included in this Box

Remote Control



Samsung Smart Control



Batteries (2 AA)

Also included

- User manual
- Regulatory guide
- 3D Active Glasses

Stand Parts and Cables



Base



Stand Mount



Screws (x8)



Power Cord



Cable Holder



Wall Mount Adapter (55 inches and above models)



IR Extender Cable

2 Assemble

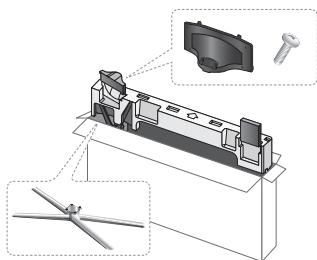

- 1** Locate the Base, Stand Mount, and Screws in the box and set them aside.

 Remove the top portion of the box to locate the stand parts.

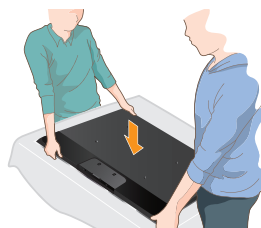

- 2** Place the TV on a soft surface, screen side down. Use the Styrofoam to protect the screen.

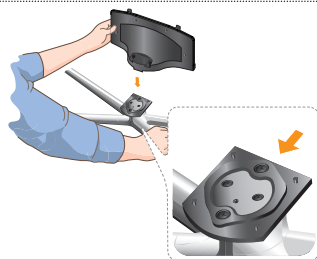

- 3** Fit the Base and Stand Mount together, making sure the notch on the Stand Mount aligns with the Base.

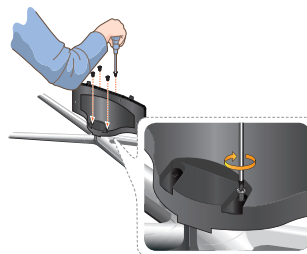

- 4** Insert 4 screws, and then use a screwdriver to secure the Base to the Stand Mount.

40 - 55 inches models:
 x4 (M4 X L12)

60 inches and above models:
 x4 (M4 X L10)

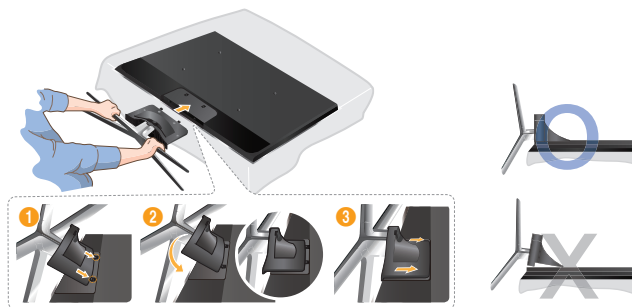

- 5** Holding the stand parallel to the screen, slide the Mount into the notches on the back of the TV.

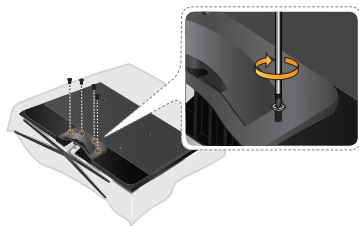

- 6** Insert 4 screws, and then use a screwdriver to secure the stand to the TV.

40 - 55 inches models:

 x4 (M4 X L12)

60 inches and above models:

 x4 (M4 X L10)



- 7** Attach the cable holder to the back of the stand. When you are done connecting devices to your TV, you can use the cable holder to arrange the cables.

- 8** Set the TV upright on its stand. Confirm that the TV is level and stable. You are now ready to connect external devices to the TV.

3 Connect

* Recommended Connections

Connection panel on the back of the TV



After you have connected all your external devices, plug the TV's power cord into the back of the TV. **DO NOT** plug it into a wall outlet until you have reached Section 7, Initial Setup.

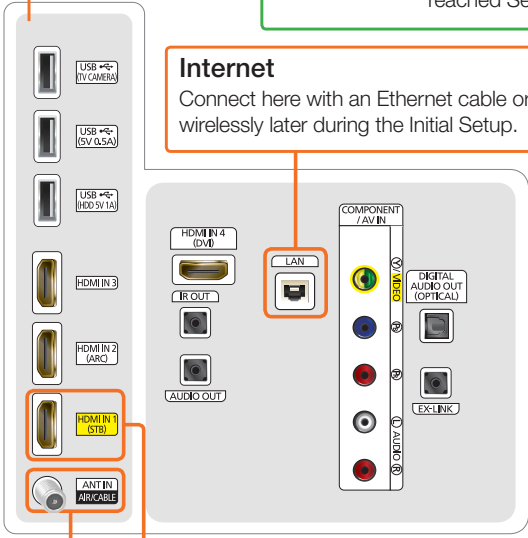

Internet

Connect here with an Ethernet cable or wirelessly later during the Initial Setup.



TV signal

Connect your coaxial cable to the Antenna In port.



Cable/Satellite/DVR

Connect your Cable box or digital video recorder with an HDMI cable.



4

Gear

* Recommended Connections

Blu-ray/DVD/Home Theater

Connect your video player using an HDMI cable.



Game console

Connect your game console or DVR using an HDMI cable.

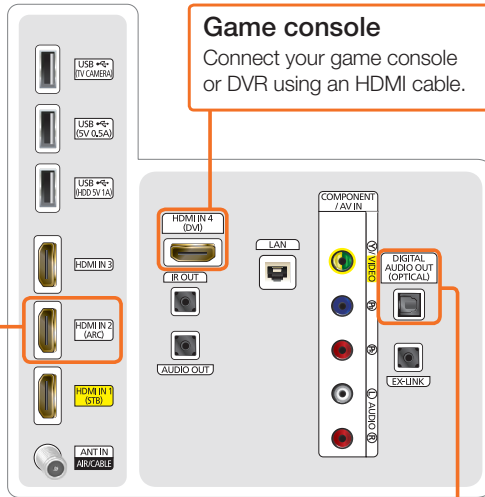

Audio

Connect a receiver/home theater using an optical audio cable.



5 Cable/SAT box

(Cable or Satellite box)

You can control your cable or satellite box with the Samsung Smart Control. To establish control, you must first set up the IR extender cable. If you don't have a cable or satellite box, skip this section.

- 1 Connect the IR extender cable to the TV's IR output connector.

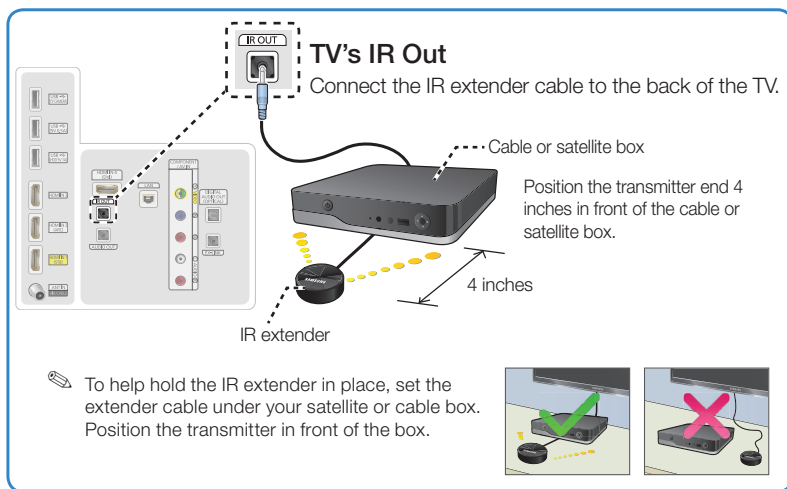

- 2 Position the transmitter end within 4 inches (10 cm) of the cable or satellite box's remote control sensor, pointing in the direction of the sensor.
 - Make sure there are no obstacles between the transmitter end of the IR extender cable and the cable or satellite box. Any obstacles will interfere with the transmission of the remote control signals.
- 3 Finalize control of your cable or satellite box when you run Initial Setup.

6 Smart Control

Introducing the Samsung Smart Control

Your TV comes with a Samsung Smart Control. Unlike conventional remote controls that have only buttons, the Samsung Smart Control has:

- Buttons for quick access to frequently used functions.
- A motion sensor that lets you move the pointer or focus on the screen by simply moving the Samsung Smart Control.

Inserting the Batteries



- 1 Gently pull on the notch in the battery cover. When the cover comes loose, remove the cover completely.
- 2 Insert 2 AA alkaline batteries, making sure to align the positive and negative polarities correctly.
- 3 Place the battery cover on the remote control, and then press the top part of the cover into the control.
- 4 Press the catches on both sides of the battery cover in the order shown in the figure above until the cover is completely attached to the remote control.

Using the Samsung Smart Control

When you start the TV for the first time by pressing the TV button on the Samsung Smart Control, the TV and the Samsung Smart Control pair, using the TV's Bluetooth function. Once the TV and Samsung Smart Control have paired, you can use the Samsung Smart Control to operate the TV.

Using Motion Sensor Control

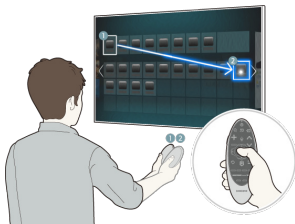

Place a finger on the touch pad, and then move the Samsung Smart Control. A pointer appears on the screen. Move the Samsung Smart Control. The pointer moves in the direction you moved the Samsung Smart Control. If you stop using the Motion Function, even momentarily, put your finger on the touch pad, and then move the Samsung Smart Control again to re-start the function.

Moving the Focus, Pointer, or Cursor Using the Directional Buttons



Press the directional buttons (up, down, left, and right) to move the focus, pointer, or cursor in the direction you want.

Selecting an Item/Entering a Menu by Pressing the Touch Pad



To enter a menu or select an item, highlight the item or the menu title, or move the pointer over it, and then press the touch pad.

Pairing the Samsung Smart Control Again

If you need to re-establish the connection between the TV and the Samsung Smart Control, point the Samsung Smart Control at the remote control sensor of the TV, and then press the **RETURN** button and **GUIDE** button simultaneously for 3 seconds or more.



7 Initial Setup

When you turn on your TV for the first time, it immediately starts the Initial Setup. During Initial Setup, your TV pairs with the Samsung Smart Control, connects to your home network, implements Smart Hub agreements, links to the source of your live TV signal, and sets up control of your Cable or Satellite box.

Information You Need

Have the following information on hand before you turn on your TV for the first time:

- Your wireless network's password. (Make sure your network is on.)
- Your Postal or Zip code.
- The name and location of your cable or satellite provider (if you use one).

Internet Access

The TV must be connected to the Internet to use the Smart Features. If you have a wireless network, confirm that your network router is working before you start the initial setup. If you have a wired network, connect the TV to the network with an Ethernet cable before you begin (CAT 7 cable preferred).

Running Initial Setup

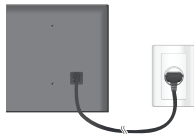

- 1 Plug your TV into a wall outlet.
- 2 Aim the Samsung Smart Control at the TV.

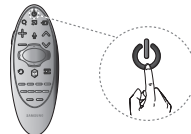

- 3 Press the **TV** button on the Samsung Smart Control to turn on the TV, and then follow the directions on the screen.

Once your Samsung Smart Control pairs, you can use the Samsung Smart Control's motion sensor function to move the pointer on the screen. To use the motion sensor function, rest a finger on the touch pad, and then move the Samsung Smart Control. To select items, press the touch pad.

To learn more about operating your TV and its Smart Features, see your TV's user's manual or launch the TV's built-in e-Manual. Congratulations on the purchase of your new Smart TV!

Common issues

Can't Connect to Network or Apps (For Internet supported models only)

- Make sure the TV has a network connection (**MENU > Network > Network Status**).
- Contact your Internet service provider.

No Picture/Sound or Distorted Picture/Sound from an External Device

- Make sure your connection to the device is correct.
- Perform a TV Self Diagnosis to identify the problem (**MENU > Support > Self Diagnosis > Sound or Picture Test**).
- Change the picture size (**MENU > Picture > Picture Size > Picture Size**).

Poor Picture Quality

- Select High Definition (HD) channels or programs.

Your Settings are Lost after 5 Minutes

- Change to Home Mode (**MENU > Support > Use Mode > Home Use**).

"Weak or No Signal" Displayed in TV Mode/Cannot Find Channel

- Press the **SOURCE** button on your remote.
- If the TV is not connected to a cable or satellite box, run Auto Program to search for channels (**MENU > Broadcasting > Auto Program**).

Can't See All Apps or Apps Not Working

- Reset Smart Hub (**MENU > Smart Hub > Smart Hub Reset**).

The stand is wobbly or crooked

- Make sure the indicator arrows on the stand and stand holder are properly aligned.

The TV won't turn on

- Make sure all cables are fully inserted and that the remote has batteries installed.

My remote, gestures, and/or voice does not work

- The TV ships with protective stickers covering some of the sensors. Make sure all of the stickers have been removed.

More help

REQUIRE ASSISTANCE WITH YOUR PRODUCT?

Purchase any Samsung TV and you'll enjoy the convenience of Samsung Service. If you require any assistance with your TV, first try any of Samsung's helpful support options listed here.

Troubleshooting

- For more quick solutions to common issues, see Troubleshooting and Maintenance in the user's manual.

Built-in user manual

- On the Samsung Smart Control, press the **KEYPAD** button, and then select **e-Manual** on the On-Screen Remote. You can also select **Support** > **e-Manual** in the TV's menu.

Scan the QR code to view our helpful How-to Videos



Scan this with your smart phone to see helpful videos.

If you experience issues, please do not take the TV back to the store.

In the United States of America, call us at 1-800-SAMSUNG (1-800-726-7864) or visit us at www.samsung.com or www.samsung.com/spn for support and warranty service.

Tech Support and Chat

- www.samsung.com/support

Remote Support

- Samsung Remote Support service offers you one-on-one support with a Samsung Technician who can remotely diagnose your TV.

For Remote Support:

- 1 Call the Samsung Contact Center at 1-800-SAMSUNG and ask for remote support.
- 2 Open the menu on your TV and go to the **Support** section.
- 3 Select **Remote Management**, and then read and agree to the service agreements. When the PIN screen appears, provide the PIN number to the agent.
- 4 The agent accesses your TV.



Samsung Smart TV

Setup Guide



BN68-05869A-03